

## Installation, Operation and Maintenance Manual

Please read and save these instructions for future reference. Read carefully before attempting to assemble, install, operate or maintain the product described. Protect yourself and others by observing all safety information. Failure to comply with these instructions will result in voiding of the product warranty and may result in personal injury and/or property damage.

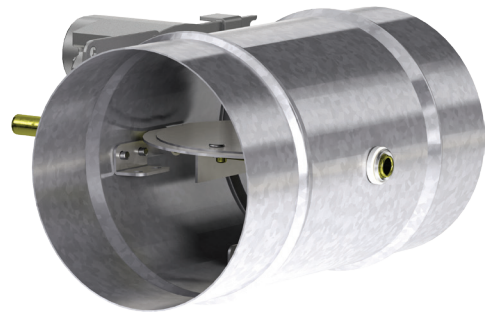

These instructions apply to 1½ hour rated fire and combination fire smoke dampers mounted in: 1) masonry, block, or stud walls and 2) concrete floors or ceilings. Specific requirements in these instructions are mandatory. Dampers must be installed in accordance with these instructions to meet the requirements of UL 555 and/or UL 555S.

### Receiving and Handling

Upon receiving dampers, check for both obvious and hidden damage. If damage is found, record all necessary information on the bill of lading and file a claim with the final carrier. Check to be sure that all parts of the shipment, including accessories, are accounted for.

Dampers must be kept dry and clean. Indoor storage and protection from dirt, dust, and the weather is highly recommended. Do not store at temperatures in excess of 100°F (38°C).

### SAFETY WARNING

Improper installation, adjustment, alteration, service or maintenance can cause property damage, injury or death. Read the installation, operating, and maintenance instructions thoroughly before installing or servicing this equipment.

## Table of Contents

General Information . . . . .	2
Electrical Guidelines . . . . .	2
Pre-Installation Guidelines . . . . .	2
Preparation of Openings . . . . .	3
Clearances Required Between Damper Sleeves and Wall/Floor Openings . . . . .	4
Inserting Damper into Wall/Floor Openings . . . . .	5
Securing the Damper/Sleeve Assembly to Wall and Floor Openings . . . . .	6
Duct to Sleeve Connections . . . . .	6
Actuator and Temperature Response Device Connections . . . . .	6
Blade Orientation . . . . .	8
Damper Maintenance . . . . .	8
Damper Troubleshooting . . . . .	8

## General Information

“UL CLASSIFIED (see complete marking on product)”

“UL CLASSIFIED to Canadian safety standards (see complete marking on product)”

Standard 555 & 555S (Listing #R13317)

## Installation Supplements

Refer to the appropriate Greenheck installation supplements for special requirements ([www.greenheck.com](http://www.greenheck.com) links are underline):

- [Fusible Link Replacement](#)
- [Greenheck Test Switch](#)
- [Metal Stud in Shaftwall Partition](#)
- [Open or Closed Indicator \(OCI\)](#)
- [Resettable Link \(RRL\)](#)
- [Resettable Link with Blade Indicator](#)
- [Round Installed in Concrete Floor With Steel Deck](#)
- Smoke Detector - Various Types
- [Temperature Limited Override \(TOR\)](#)

Online version of this installation is available at [www.greenheck.com](http://www.greenheck.com).

[Round Fire and Combination Fire Smoke Dampers](#)



## Electrical Guidelines

### Electrical Guidelines

All wiring shall be done in accordance with the National Electrical Code ANSI/NFPA-70 latest edition, any local codes that may apply, and wiring diagrams developed in compliance with the job or project design and specifications

### Important!

Electrical input may be needed for this equipment. This work should be performed by a qualified electrician. Verify power before wiring actuator. Greenheck is not responsible for any damage to, or failure of the unit caused by incorrect field wiring. To avoid causing death or serious bodily harm to building occupants, follow all instructions carefully. Dampers must close completely to preserve the integrity of the fire smoke separation.

## Pre-Installation Guidelines

The following items will aid in completing the damper installation in a timely and effective manner.

- 1) Check the drawings for proper damper locations within the building. Visually inspect the damper for damage and verify that the Reusable Resettable Link (RRL) is in place and has not activated if provided. These electric links have a button for resetting. Visually inspect the fusible link (if provided) to verify its not missing or broken. Replace link as necessary.
- 2) Lift or handle damper using sleeve or frame. Do not lift damper using blades or actuators.
- 3) Do not install screws into area of the damper frame that would interfere with damper operation.
- 4) Damper has label indicating position of damper and sleeve assembly in the wall. Install accordingly to comply with manufacturer's appropriate UL Classification file number.
- 5) Damper must be installed into duct or opening square and free of twist or other misalignment. Out of square, racked, twisted or misaligned installations can cause excessive leakage and/or torque requirements to exceed damper/actuator design.
- 6) Damper and actuator must be kept clean and protected from dirt, dust and other foreign materials prior to and after installation. Examples of such foreign materials include but are not limited to:
  - a) Mortar dust
  - b) Drywall dust
  - c) Firesafing materials
  - d) Wall texture
  - e) Paint overspray
- 7) Damper should be sufficiently covered as to prevent overspray if wall texturing or spray painting will be performed within 5 feet of the damper. Excessive dirt or foreign material deposits on the damper can cause excessive leakage and/or torque requirements to exceed damper/actuator design.
- 8) Caulking is not necessary, nor is it allowed, between the damper sleeve and the wall or floor opening (annular space). However, caulking may be applied to the retaining plate.
- 9) ACCESS: Suitable access (such that RRL's and actuators can be maintained, etc.) must be provided for damper inspection and servicing. Where it is not possible to achieve sufficient size access, it will be necessary to install a removable section of duct. (Refer to NFPA 90A).
- 10) The Code Authority Having Jurisdiction (AHJ) must evaluate and provide approval of final installation where variations to these instructions are necessary.

# Preparation of Openings

- Frame wall openings as shown below (see **Figure 1, 2, & 2A**).
- Gypsum wall board must be fastened 12 in. (305 mm) on center (O.C.) to all stud and runner flanges surrounding opening.
- Prepare opening between studs and sleeve assembly as shown below (see **Figure 3 & 4**).
- All construction and fasteners must meet the requirements of the appropriate wall design (See UL Fire Resistance Directory) and/or local codes.

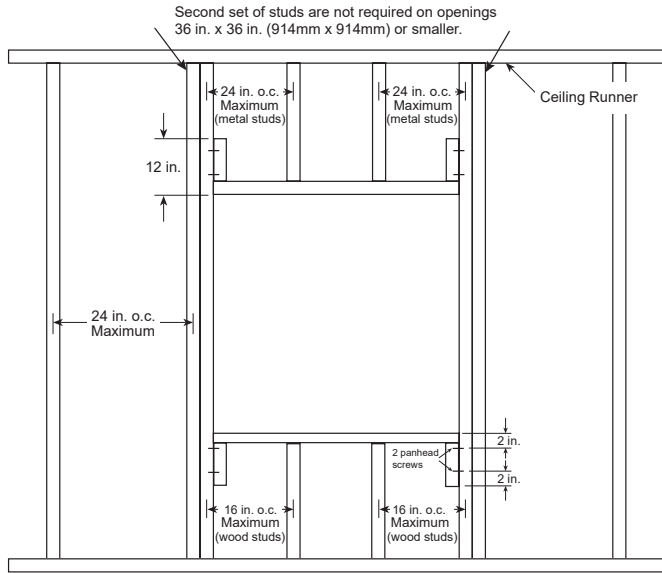

**Figure 1**

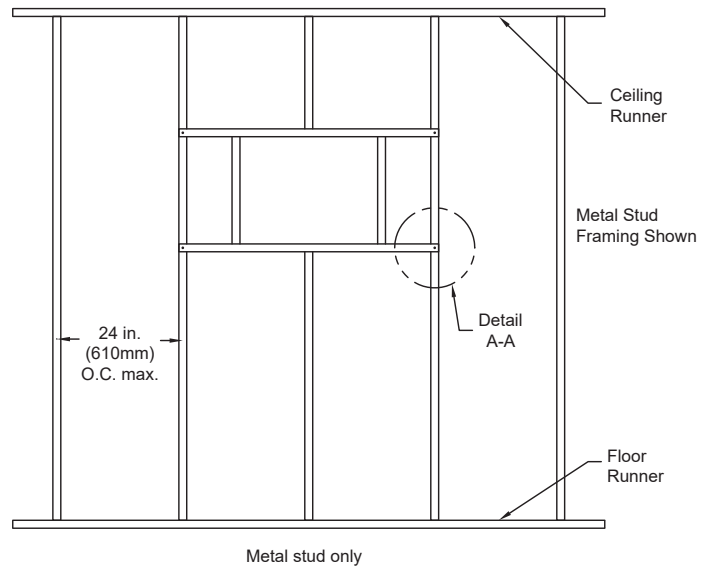

**Figure 2**

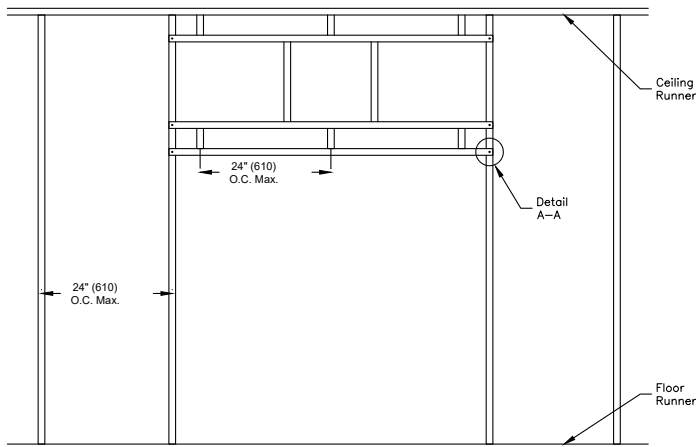

**Figure 2A**

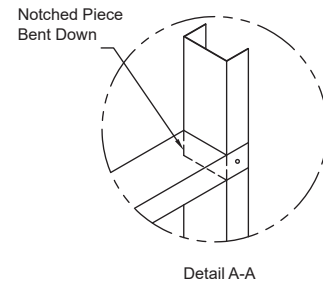

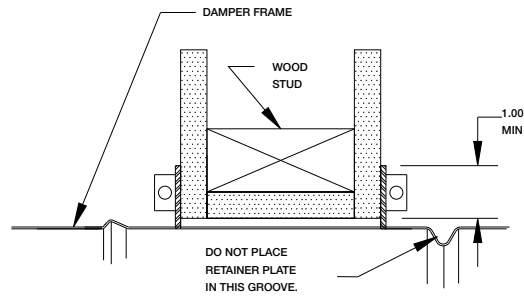

Figure 3: wood stud

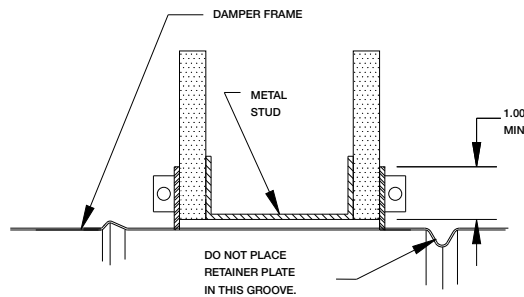

Figure 4: metal stud

## Clearances Required Between Damper Sleeves and Wall/Floor Openings

Fire damper assemblies expand during periods of intense heat. Therefore, it is essential that openings in walls or floors be larger than the fire or combination fire smoke damper assembly to allow for this expansion. The wall/floor opening must be a minimum of  $\frac{7}{8}$  in. (22 mm) larger than the outside diameter of the damper.

### Maximum Size Table

Damper Model	Maximum Size
DFDR-510	24 in. (610 mm)
FSDR-511	
SSDFDR-510	
SSFSDR-511	

## Inserting Damper into Wall/Floor Openings

Insert the damper assembly into the prepared opening, to appropriate depth (see **Figure 5 & 6**).

Special attention must be paid to ensure the following:

- 1) The  $\text{CL}$  (centerline) of the blade axle remains within the plane of the wall or floor
- 2) The sleeve does not extend more than 16 in. (406 mm) beyond the wall or floor on the actuator side of the damper and 6 in. (152 mm) on the side opposite the actuator. The sleeve may also extend up to 16 in. (406 mm) beyond the wall or floor if the damper has an access door.

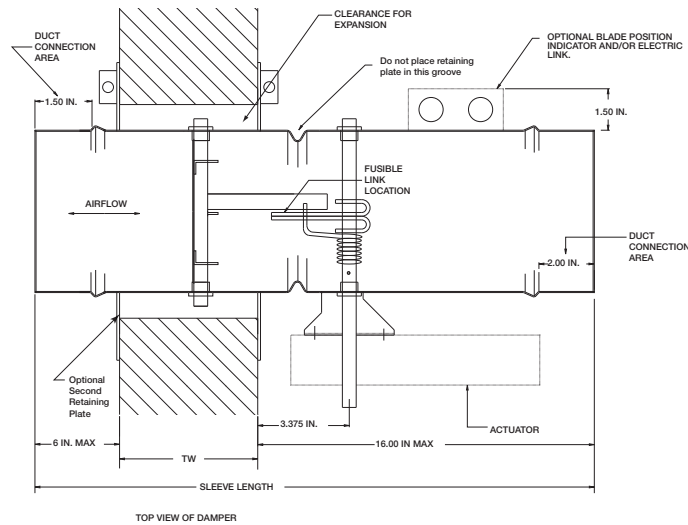

**Figure 5: FSDR/SEFSDR/SSFSDR**

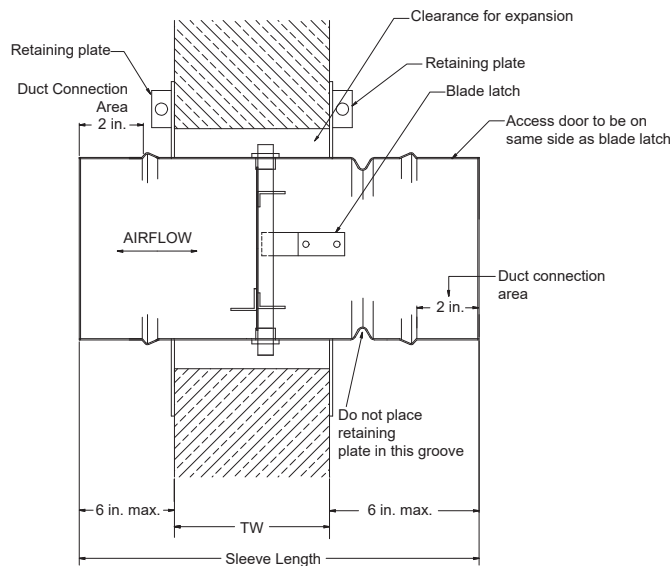
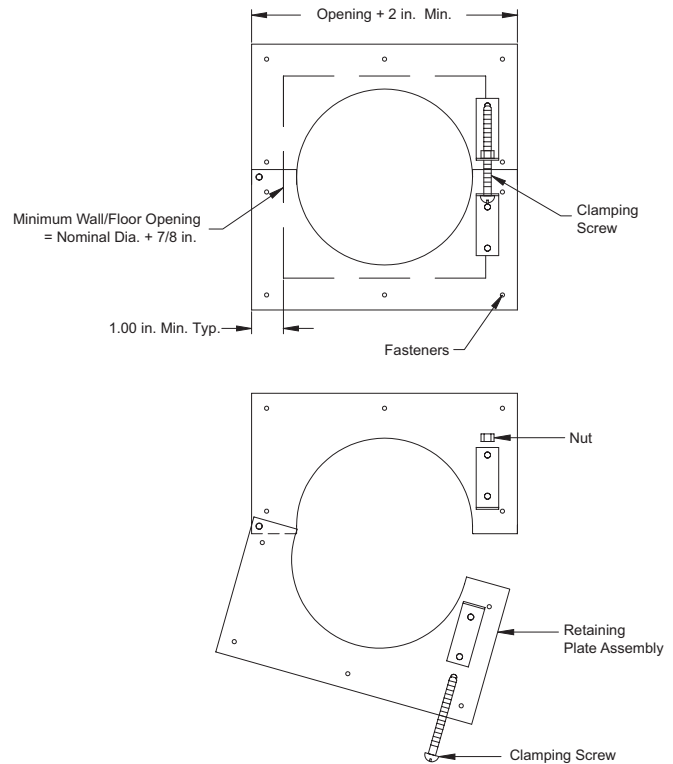

**Figure 6: DFDR/FDR/SEDFDR/SSDFDR/SSFDR**

## Securing the Damper/Sleeve Assembly to Wall and Floor Openings

Damper assemblies must be installed in wall and floor openings using a single retaining plate on either side of the wall/floor or by using a retaining plate on both sides of the wall/floor. A single retaining plate is provided with the dampers. A second retaining plate can be ordered as an option.

- The retaining plate(s) will open up for easy installation when the clamping screw is loosened. If necessary, remove the clamping screw and nut (see **Figure 7**).
- Position the retaining plate between the blade axle and the actuator shaft as shown in **Figure 5 & 6**. Do not place the retaining plate in the groove. **IMPORTANT:** The clamping mechanism should face away from the wall/floor.
- Place the damper and attached retaining plate into the wall/floor opening.
- If a second retaining plate is being used, secure it on the opposite side of the wall/floor.
- Verify position, blade orientation, and actuator clearance then tighten the retaining plate clamping screws.
- The retaining plate(s) must overlap the wall/floor opening a minimum of 1 in. (25 mm).
- Secure the retaining plate(s) to the wall at the four corners of each plate when two retaining plates are used and also within  $\frac{3}{4}$  in. (19 mm) of the center of each side when one retaining plate is used. The following fasteners shall be used:
  - #8 or #10 screws of a length such that the screw engages the steel stud/track by  $\frac{1}{2}$  in. (13 mm)(steel framing).
  - #8 or #10 screws of a length such that screw engages the wood stud by  $1\frac{3}{4}$  in. (44 mm) (wood framing)
  - Steel anchors or self tapping concrete screws penetrating masonry or block by  $1\frac{1}{4}$  in. (32 mm).



**Figure 7: Retaining Plates**

## Duct to Sleeve Connections

### Sleeve Gauge and Connection Type Requirements

Round duct connections shall be attached with #8 or #10 sheet metal screws as follows:

- Ducts 22 in. (558 mm) dia. and smaller shall have three screws.
- Ducts larger than 22 in. (558 mm) dia. up to and including 24 in. (610 mm) dia. shall have five screws.

**Note:** All connections described may have duct sealant, PA2084T duct sealant adhesive manufactured by Precision, DP1010 water base duct sealant manufactured by Design Polymeric, Grey Pookie, Ductmate PROseal<sup>®</sup>, or CL Ward S Seal applied in accordance with SMACNA recommendations.

## Actuator and Temperature Response Device Connections

### Actuator Connections

Electrical and/or pneumatic connections to damper actuators should be made in accordance with wiring and piping diagrams developed in compliance with applicable codes, ordinances and regulations (see **Electrical Guidelines**).

## Temperature Response Device Connections

**RRL:** The RRL (reusable resettable link) incorporates a single thermostat. When the thermostat temperature is reached, the sensor interrupts power to the actuator and the actuator's spring return mechanism causes the damper to close. Refer to **Figure 8** for wiring of the RRL thermostat.

**OCI:** The OCI (open or closed indicator) option contains two single pole single throw switches used to indicate the damper blade position. The switches provide a positive open and closed signal and can be used in conjunction with remote indicator lights. Refer to **Figure 9** for wiring of the OCI option.

**RRL /OCI:** The RRL/OCI performs the function of an RRL and OCI (see description above). Refer to **Figure 10** for wiring of the RRL/OCI option.

**TOR:** The TOR (temperature override device) option incorporates two thermostats with fixed settings (usually 165°F [74°C] and 350°F [177°C]). The primary sensor (the sensor with the lower temperature setting) can be bypassed by an external contact closure allowing the damper to reopen until the secondary temperature is reached (the sensor with the higher temperature setting). See **Figure 11**.

The TOR assembly contains two single pole single throw switches used to indicate damper blade position. The switches provide a positive open and closed signal and can be used in conjunction with remote indicator lights. See **Figure 11** for wiring of the TOR thermostats and indicator switches.

If either the TOR or the RRL is ordered with a pneumatic actuator, an EP switch is required with an appropriate electric power circuit to allow the electric thermostat to control the pneumatic actuator.

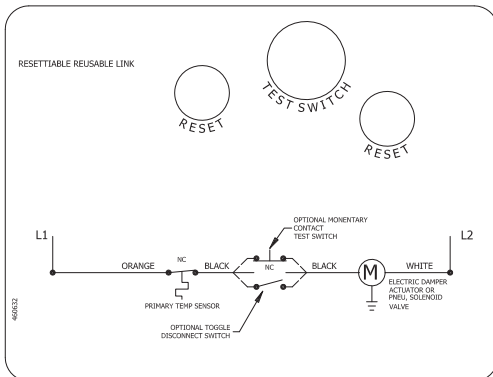

Figure 8: RRL Wiring

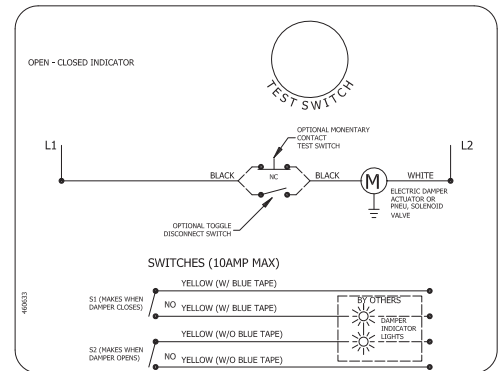

Figure 9: OCI

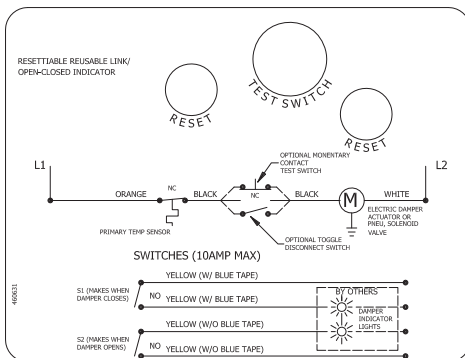

Figure 10: RRL/OCI

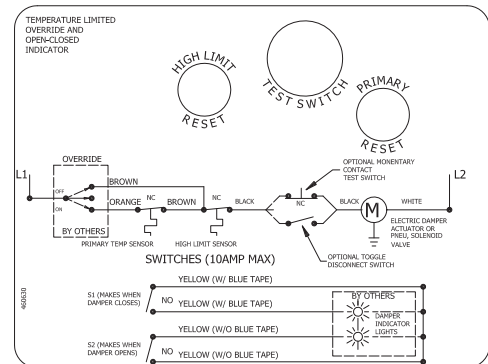

Figure 11: TOR

## Ratings (Figure 8, 9, 10, & 11)

**Integral Switch Type:** Single Pole, double throw

**Electrical Capacity:** 10 Amps, 1/3 hp, 120 or 240 Vac

1/2 Amp, 125 Vdc;

1/4 Amp 250 Vdc

5 Amps, 120 Vac "L" (lamp load)

1.0 Amps, 24 Vac

1.5 Amps, 24 Vdc

**Temperature Limit:** 165° F (standard primary sensor)

212° F (optional primary sensor)

250° F (secondary sensor)\*

350° F (secondary sensor)\*

\* based on actuator temperature rating





## Blade Orientation

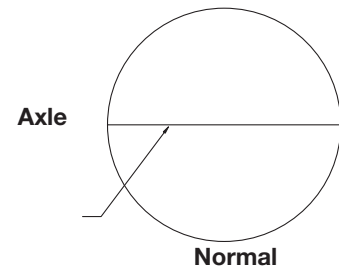
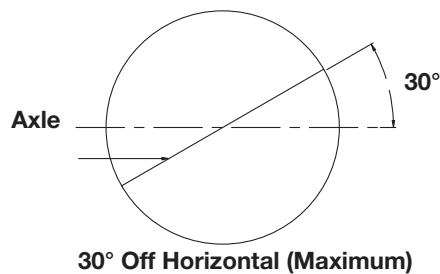
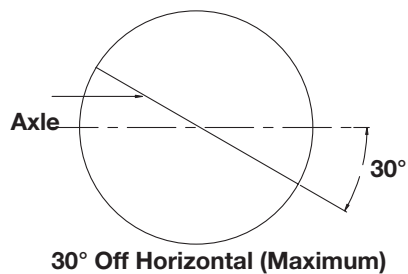

## Damper Maintenance

Dampers do not typically require maintenance as long as they are kept dry and clean. If cleaning is necessary, use mild detergents or solvents. If lubrication is desired for components such as axle bearings, jackshaft bearings and jamb seals, do not use oil-based lubricants or any other lubricants that attract contaminants such as dust.

Dampers and their actuator(s) must be maintained, cycled, and tested at minimum in accordance with:

- The latest editions of NFPA 80, 90A, 92, 101, 105, UL864, AMCA 503-03 and local codes.
- Actuator manufacturer recommendations.

## Damper Troubleshooting

The following is a possible cause and correction list for common concerns with dampers.

Symptom	Possible Cause	Corrective Action
Damper does not fully open and/or close	Frame is 'racked' causing blades to bind on jamb seals	Adjust frame such that it is square and plumb
	Actuator linkage loose	Close damper, disconnect power, adjust and tighten linkage
	Defective motor	Replace
	Screws in damper linkage	Damper installed too far into wall. Move out to line as designated on damper label
	Contaminants on damper	Clean with a non-oil based solvent (see Damper Maintenance)
RRL or TOR sensor tripped	Heat	Push reset button located on backside of RRL or TOR
Damper does not operate	No power supplied to the actuator	Add power supply

## Our Commitment

*As a result of our commitment to continuous improvement, Greenheck reserves the right to change specifications without notice.*

Product warranties can be found online at [Greenheck.com](http://Greenheck.com), either on the specific product page or in the literature section of the website at [Greenheck.com/Resources/Library/Literature](http://Greenheck.com/Resources/Library/Literature).

